

Operation Manual



BAMN-404

Medical Class N Autoclave

Thank you for Choosing Biolab products. Please read the "Operating Instructions" and "Warranty" before operating this unit to assure proper operation.

Index

01 General Introduction.....	03
02 Application Scope	03
03 Tech. Parameter	03
04 Diagram Specification	04
05 Installation	04
06 Control Panel	05
07 Operation	06
08 Emergency Condition	06
09 Maintenance and Service	08
10 Transportation and Storage	09
11 Accessory	09

01 General Introduction

This steam sterilizer is a precision instrument specializing in the operation occasion in need of simple, fast and efficient sterilization by the doctor or his/her assistants, and the doctor shall take the responsibility for such work.

This steam sterilizer is equipped with the microprocessor for intelligent control and man-machine interface for convenient operation. With the distinctions in displaying parameter and condition actively, evaluating malfunction automatically, shutting off for self-protection automatically in case of excessive temperature and pressure, this type steam sterilizer is reliable product in sterilizing.

02 Application Scope

This product is N-level sterilizer for dental, ophthalmology, operating room, laboratory, small dental equipment, surgical instruments sterilization 121°C/134°C for rapid sterilization of items.

03 Tech. Parameter

Chamber size of the Steam Sterilizer (Diameter X Depth) 16L...230mmX360mm

Chamber size of the Steam Sterilizer (Diameter X Depth) 18L...249mmX355mm

Chamber size of the Steam Sterilizer (Diameter X Depth) 23L...249mmX460mm

Rated Voltage.....230~, 50Hz

Sterilizing (Pressure/temp.).....0.9~1.1Bar/121°C

2.0~2.3Bar/134°C







(Both of above are Under Standard Atmospheric pressure)

Rated Power.....750VA

Fuse-Melting pipe..... T15A

Operating Temp.....0-40°C

04 Diagram Specification

Symbol	Meaning
	CAUTION
	Warning: dangerous voltage
	WEEE MARKING
	DATE OF MANUFACTURE
	SERIAL NUMBER
	CONSULT INSTRUCTIONS FOR USE
	Earthing

05 Installation

The clearance between the exterior side surface of the steam sterilizer and the ambient neighboring articles shall be 10cm as retained, and the top surface shall be 20cm retained. The air-cooling window attached to the exterior surface of the steam sterilizer shall be non-clog by dust or articles, and the steam sterilizer shall be located in the proper air flowing environment by recommendation of the supplier.

The steam sterilizer shall be installed on the horizontal working base.

PREPARATION BEFORE OPERATION

Before operation, please connect well to the power source. Connect the power source hole under the back left side of the steam sterilizer and the power socket by the attached power cable inside the product's package so as to switch on the steam sterilizer. Push down the main power button at the right bottom corner of the front side, when the Switch indicator bright it

means that the steam sterilizer get through with the electric power, and the process then is in initialization status with "LD" being shown on the screen. The steam sterilizer is not heated while under such initialization status.

06 Control Panel

6.1 Pressure display window

Real-time display the air pressure inside the cavity.

Unit: Bar

6.2 Temperature display window

Real-time display the temperature inside the cavity.

Unit: °C

6.3 Status/ malfunction code number display window

Applied for displaying kinds of status of the steam sterilizer during its working time. See more details in "Appendix working status display form".

When alarm occurs to the steam sterilizer, the digital pipe of the display will show the alarm code number, the user can find out the malfunction part. (Once the malfunction occurring to the steam sterilizer, please contact the service center or distributor immediately).

6.4 ""button

It is used to be the choice especially for the working temperature. There are two working temperature for choice: 121 °C or 134 °C, whose light will on after being chosen.

6.5 "UNWRAPPED" button

It's used to the sterilization choice especially for the unwrapped devices. The working temperature is 121°C or 134°C.

After having been chosen, its indicator light is on.

6.6 "WRAPPED" button

It's used to be the sterilization choice especially for the wrapped devices. The working temperature is 121°C or 134°C.

After having been chosen, its indicator light is on.

6.7 "START/STOP" button

Press down the starting button for starting the sterilizing process.

If you want exit Process, please turn off the electric power.

Note: If forced exit or outage, please wait for 10 minutes, then open the door, in case of the air pressure indoor.

Must wait for the pressure display "0 Bar" can open the door,

6.8 "READY" indicator light

Door lock indicator light. When the indicator light light, it means can start sterilizing, After launching the indicator light to put out.

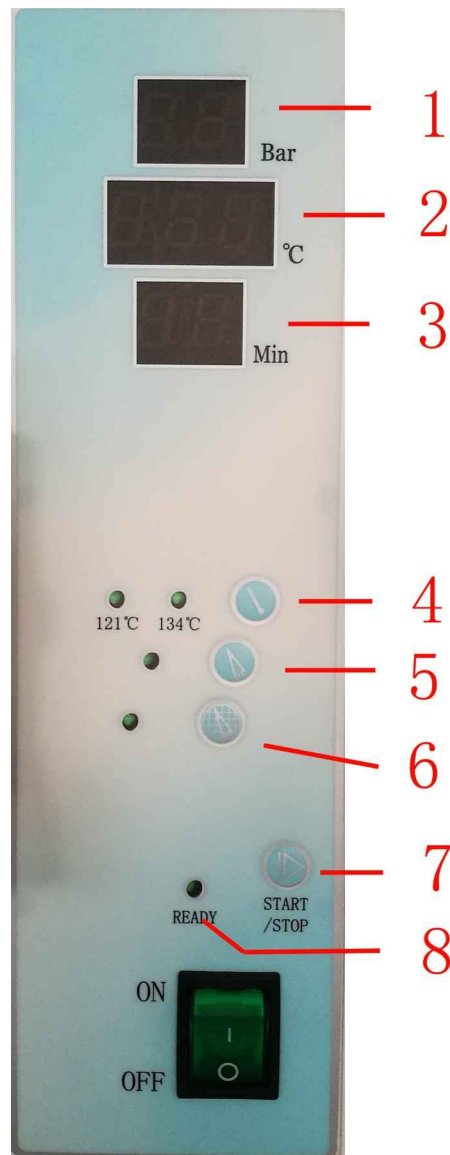

07 Operation

Before operation, please connect well to the power source. when display bright it means that the steam sterilizer get through with the electric power, and the process then is in initialization status with “LD” being shown on the screen. The steam sterilizer is not heated while under such initialization status. Otherwise, you need to close the door completely. Then press the “Start” button to start the sterilizing.

7.1 Water filling

After turning on the power to the steam sterilizer, if the “Green” blob light is flashing, means the low water level in the source water tank, please fill more distilled water until the light off and with a “du” sound. Fill about 1500ml distilled water(3 cups) each time.

7.2 Close the door after putting in the apparatus to be sterilized, and revolve the handle to the maximum position.

7.3 Locks indicator “READY” light, 7.4 “ READY ”, “ START ”press the "START" key to start working. : “ START ”Note: If the door is not completely closed, the machine can't work when press down the "START" button. If the door is opening during working process, the working status display will flash “E5”as alarm and the steam sterilizer will stop working until restart again by switching off the power and dismissing the alarm.

7.5 “ END ”, 7.4 Status display "ED", and has a beep after sterilizing process, then you can open the door and take the sterilized apparatus out.

7.6 Sterilizing cycle

PROCEDURE	TEMPERTURE	PRESSURE	TIME
UNWRAPPED	134°C	2.1Bar	4 minutes
	121°C	1.1 Bar	10 minutes
WRAPPED	134°C	2.1 Bar	8 minutes
	121°C	1.1 Bar	20 minutes

08 Emergency Condition

During the running time, the steam sterilizer will automatically raise the alarm, release pressure, stop heating and display the warning code. (The definition of the warning code is as the below: malfunction code and resolving method) for ensuring the safety of the operator if the emergencies occur.

Any emergencies happen, please check the warning code table for resolving the according malfunctions. If not possible to resolve, please contact the dealers. We will try our best to provide help to you in short time.

 Must wait for the pressure display “0 Bar” can open the door,

 there will be set aside heat and residual hot water, Operator also need keep away from it , prevent burns!

Malfunction code and resolving measures

0	E	Heating failure	Check the heating heater Check vent valve of water is normal Check water level Check for gas leaking away
0	E	Failure to maintain the temperature	Check temperature sensor Check vent valve of water is normal Check water level
0	E	Excessive Temperature (temperature sensor fault)	Check temperature sensor
0	E	Pressure can not be released	Check the exhaust, drain valve
0	E	Door switch bounce	Check the door knob, microswitch

Others:

- ① Turn on the power, display board don't show. Check if the display board loosen or not.
- ② When or after close the door, Locks indicator not light, check if the feeler lever of microswitch touch the microswitch.

09 Maintenance and Service

9.1 Disinfect and clean the interior surface of the steam sterilizer room by Medicinal alcohol once a month.

9.2 Replace the fuse-melter.

- (1) Shut off the power
- (2) Revolve the fuse base by counter-clockwise by screwdriver to bring out the melting fuse to be replaced;
- (3) Replace the new fuse and reset the fuse base on the original position, then use the screwdriver to fasten the base by clockwise.
- (4) Check the correctness of the parameter of the new fuse replaced.

9.3 Clean the sealing ring periodically

The user shall clean the sealing ring periodically for avoiding the influence to the seal caused by the dust/dirt left due to the long period use. Use the smooth cloth with distilled water to wipe the surface of the sealing ring or sealing cap gently. The user shall discharge the sealing ring for further cleaning or replacement if the air-leaking problem can not be resolved after the above process (The user shall discharge the sealing ring periodically for cleaning and inspection as recommendation by the supplier). Put back the ring to the original door groove after cleaning. Most Important: the inset work must be done equably to the groove During the installation, the laid four equal points of the ring must be inserted to the groove firstly, later for the same work for the remaining segments of the ring. After finishing, press the sealing ring equally by the force of hand.

9.4 Shut off the power before service or components' replacement, and the service or replacement work shall be done by the supplier or his designated technician.

10 Transportation and Storage

The steam sterilizer shall be transferred and stored with the below conditions:

Ambiance temperature: -40°C --+55°C

Relative humidity: < 85%

Atmospheric pressure: 500HPA-1060HPA

11 Accessory

1.	Draining pipe	1 pc
2.	Tray	3 pcs
3.	Plug	1 pc
4.	Braket	1 pc
5.	Manual holder	1 pc
6.	Fuse	2 pcs
7.	Operation manual	1 pc
8.	Measuring cup	1 pc
9.	Sealing ring	1 pc
10.	O ring of tap	2 pcs

APPENDIX

I Working status display table:

NO.	Display	Explain
1	Ld	Prepare/preheating state
2	He	Heating state
3	working time	Sterilization state
4	Ed	end-of-job

II Steam Way : steam ff Map

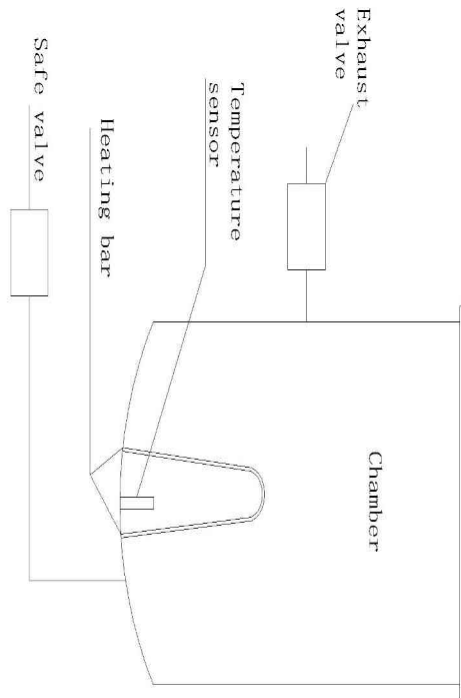

III Wiring Map

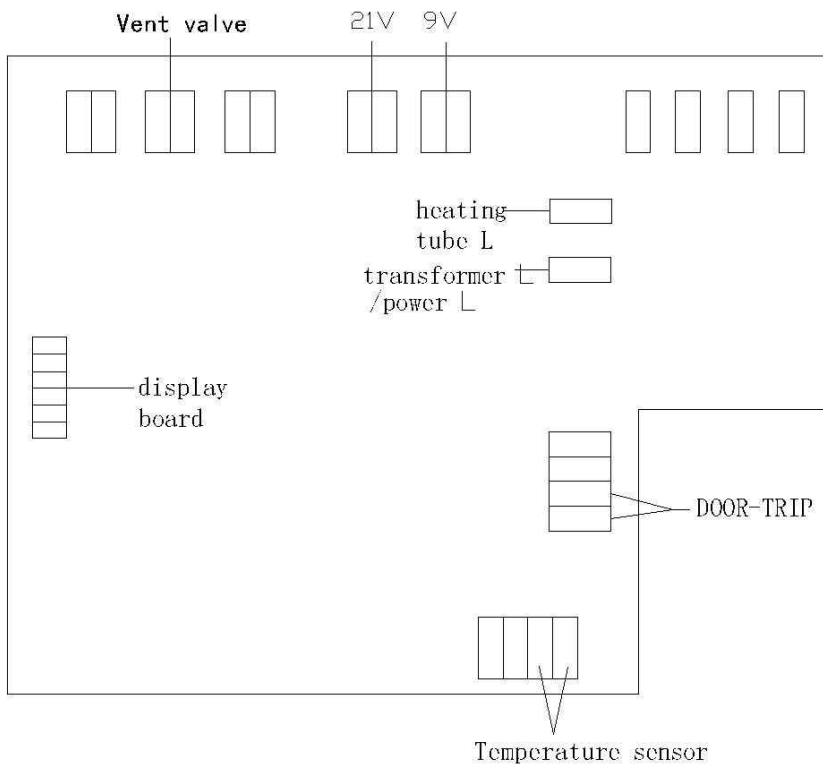



Email: contact@biolabscientific.com

Website: www.biolabscientific.com